



# Nová generace energeticky úsporných trubicových světel LED PLL

## CorePro LED PLL

Řada Philips CorePro LED PLL je ideálním řešením pro modernizaci svítidel typu downlight v širokém rozsahu aplikací celkového osvětlení. Integruje světelné zdroje LED do provedení odpovídajícího tradičním zářivkám a nabízí značné úspory energie po celou dobu životnosti, která je oproti zářivkovým alternativám dvojnásobná.

### Výhody

- Nižší provozní náklady díky nižší spotřebě energie oproti tradičním zdrojům PLL, nižší náklady na údržbu díky 2–3krát delší životnosti oproti tradičním zdrojům
- Jednoduchá výměna zdrojů kus za kus, možnost použití existujících svítidel bez velkých zásahů díky provedení podobnému zdrojům PLL
- Nejrychlejší a nejsnadnější způsob modernizace existujících svítidel na technologii LED

### Vlastnosti

- Vysoká kvalita světla, bez blikání nebo stroboskopického efektu
- Okamžitý 100% výkon
- Volitelná teplota chromatičnosti 3000 K, 4000 K nebo 6500 K

### Aplikace

- Pohostinství
- Obchody
- Kanceláře (schodiště, chodby)
- Průmyslové zóny

# CorePro LED PLL

## Versions



## Rozměrové výkresy

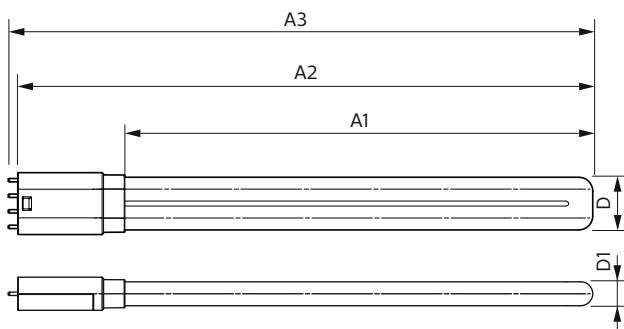
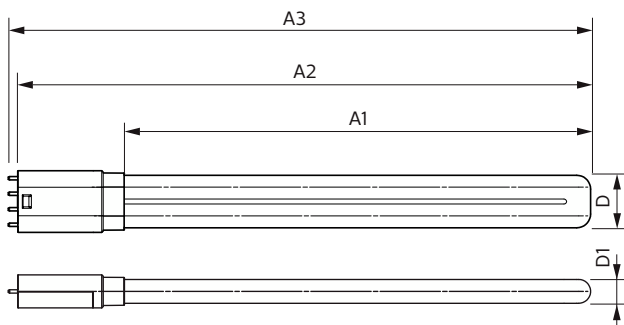

Product	D1	D2	A1	A2	A3
CorePro LED PLL HF 16.5W 840 4P 2G11	43,6 mm	23,4 mm	329,5 mm	405 mm	411,6 mm
CorePro LED PLL HF 16.5W 830 4P 2G11	43,6 mm	23,4 mm	329,5 mm	405 mm	411,6 mm
CorePro LED PLL EM/Mains 16.5W 830 4P	17 mm		330 mm	405 mm	412 mm
CorePro LED PLL EM/Mains 16.5W 840 4P	17 mm		330 mm	405 mm	412 mm

Product	D	D1	A1	A2	A3
CorePro LED PLL HF 24W 840 4P 2G11	37,6 mm	17 mm	453 mm	528,5 mm	535,1 mm
CorePro LED PLL HF 24W 830 4P 2G11	37,6 mm	17 mm	453 mm	528,5 mm	535,1 mm
CorePro LED PLL HF 12W 830 4P 2G11	17 mm		250 mm	312 mm	319 mm
CorePro LED PLL EM/Mains 12W 830 4P	17 mm		250 mm	312 mm	319 mm
CorePro LED PLL HF 12W 840 4P 2G11	17 mm		250 mm	312 mm	319 mm
CorePro LED PLL EM/Mains 12W 840 4P	17 mm		250 mm	312 mm	319 mm
CorePro LED PLL Mains 24W 830 4P	17 mm		453 mm	528 mm	535 mm
CorePro LED PLL Mains 24W 840 4P	17 mm		453 mm	528 mm	535 mm

## Rozměrové výkresy

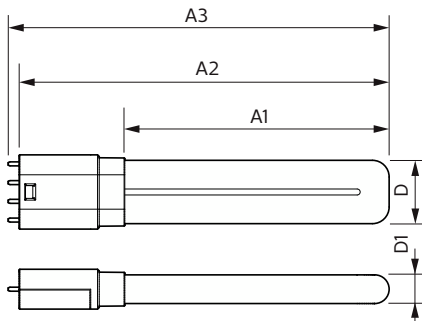

Product	D1	D2	A1	A2	A3
CorePro LED PLL HF 8W 830 4P 2G11	17 mm	155 mm	217 mm	224 mm	
CorePro LED PLL HF 8W 840 4P 2G11	17 mm	155 mm	217 mm	224 mm	
CorePro LED PLL EM/Mains 8W 830 4P	17 mm	156 mm	218 mm	224 mm	
CorePro LED PLL EM/Mains 8W 840 4P	17 mm	156 mm	218 mm	224 mm	

Controls and dimming	
Stmívatelné	Ne
Operating and electrical	
Doba spuštění (jmen.)	0,5 s
General information	
Patice	2G11
Jmenovitá životnost (jmen.)	30000 h
Light technical	
Vyzařovací úhel (jmen.)	160 °
Světelný tok na konci jmenovité životnosti (jmen.)	70 %
Mechanical and housing	
Tvar žárovky	Trubice, jedna patice
Temperature	
Okolní teplota (max.)	45 °C
Okolní teplota (min.)	-20 °C
Teplota skladování (min.)	-40 °C

## Approval and application

Order Code	Full Product Name	Spotřeba energie kWh/1000 h
73966200	CorePro LED PLL HF 16.5W 830 4P 2G11	17 kWh
73974700	CorePro LED PLL HF 16.5W 840 4P 2G11	17 kWh
15707100	CorePro LED PLL EM/Mains 16.5W 830 4P	17 kWh
15709500	CorePro LED PLL EM/Mains 16.5W 840 4P	17 kWh
82839700	CorePro LED PLL HF 24W 830 4P 2G11	24 kWh
82841000	CorePro LED PLL HF 24W 840 4P 2G11	24 kWh
15711800	CorePro LED PLL Mains 24W 830 4P	24 kWh
15713200	CorePro LED PLL Mains 24W 840 4P	24 kWh
48676800	CorePro LED PLL HF 8W 830 4P 2G11	8 kWh
48678200	CorePro LED PLL HF 8W 840 4P 2G11	8 kWh
15699900	CorePro LED PLL EM/Mains 8W 830 4P	8 kWh
15701900	CorePro LED PLL EM/Mains 8W 840 4P	8 kWh
48680500	CorePro LED PLL HF 12W 830 4P 2G11	12 kWh
48682900	CorePro LED PLL HF 12W 840 4P 2G11	12 kWh
15703300	CorePro LED PLL EM/Mains 12W 830 4P	12 kWh
15705700	CorePro LED PLL EM/Mains 12W 840 4P	12 kWh

## Operating and electrical

Order Code	Full Product Name	Vstupní frekvence	Napětí (jmen.)	Příkon (nom.)
73966200	CorePro LED PLL HF 16.5W 830 4P 2G11	39000-71000 Hz	53-77 V	16,5 W
73974700	CorePro LED PLL HF 16.5W 840 4P 2G11	39000-71000 Hz	53-77 V	16,5 W
15707100	CorePro LED PLL EM/Mains 16.5W 830 4P	50 až 60 Hz	220-240 V	16,5 W
15709500	CorePro LED PLL EM/Mains 16.5W 840 4P	50 až 60 Hz	220-240 V	16,5 W
82839700	CorePro LED PLL HF 24W 830 4P 2G11	20000-70000 Hz	53-77 V	24 W

Order Code	Full Product Name	Vstupní frekvence	Napětí (jmen.)	Příkon (nom.)
82841000	CorePro LED PLL HF 24W 840 4P 2G11	20000-70000 Hz	53-77 V	24 W
15711800	CorePro LED PLL Mains 24W 830 4P	50 až 60 Hz	220-240 V	24 W
15713200	CorePro LED PLL Mains 24W 840 4P	50 až 60 Hz	220-240 V	24 W
48676800	CorePro LED PLL HF 8W 830 4P 2G11	20-80 000 Hz	20-60 V	8 W
48678200	CorePro LED PLL HF 8W 840 4P 2G11	20-80 000 Hz	20-60 V	8 W

## CorePro LED PLL

Order Code	Full Product Name	Vstupní frekvence	Napětí (jmen.)	Příkon (nom.)
15699900	CorePro LED PLL EM/ Mains 8W 830 4P	50 až 60 Hz	220-240 V	8 W
15701900	CorePro LED PLL EM/ Mains 8W 840 4P	50 až 60 Hz	220-240 V	8 W
48680500	CorePro LED PLL HF 12W 830 4P 2G11	20-80 000 Hz	20-60 V	12 W

Order Code	Full Product Name	Vstupní frekvence	Napětí (jmen.)	Příkon (nom.)
48682900	CorePro LED PLL HF 12W 840 4P 2G11	20-80 000 Hz	20-60 V	12 W
15703300	CorePro LED PLL EM/ Mains 12W 830 4P	50 až 60 Hz	220-240 V	12 W
15705700	CorePro LED PLL EM/ Mains 12W 840 4P	50 až 60 Hz	220-240 V	12 W

### General information

Order Code	Full Product Name	Cyklus přepínání
73966200	CorePro LED PLL HF 16.5W 830 4P 2G11	50000
73974700	CorePro LED PLL HF 16.5W 840 4P 2G11	50000
15707100	CorePro LED PLL EM/Mains 16.5W 830 4P	200000
15709500	CorePro LED PLL EM/Mains 16.5W 840 4P	200000
82839700	CorePro LED PLL HF 24W 830 4P 2G11	50000
82841000	CorePro LED PLL HF 24W 840 4P 2G11	50000
15711800	CorePro LED PLL Mains 24W 830 4P	200000
15713200	CorePro LED PLL Mains 24W 840 4P	200000

Order Code	Full Product Name	Cyklus přepínání
48676800	CorePro LED PLL HF 8W 830 4P 2G11	50000
48678200	CorePro LED PLL HF 8W 840 4P 2G11	50000
15699900	CorePro LED PLL EM/Mains 8W 830 4P	200000
15701900	CorePro LED PLL EM/Mains 8W 840 4P	200000
48680500	CorePro LED PLL HF 12W 830 4P 2G11	50000
48682900	CorePro LED PLL HF 12W 840 4P 2G11	50000
15703300	CorePro LED PLL EM/Mains 12W 830 4P	200000
15705700	CorePro LED PLL EM/Mains 12W 840 4P	200000

### Light technical

Order Code	Full Product Name	Kód barvy	Index		
			Náhradní teplota chromatičnosti (jmen.)	barevného podání (jmen.)	Světelný tok (jmen.)
73966200	CorePro LED PLL HF 16.5W 830 4P 2G11	830	3000 K	83	2000 lm
73974700	CorePro LED PLL HF 16.5W 840 4P 2G11	840	4000 K	83	2100 lm
15707100	CorePro LED PLL EM/Mains 16.5W 830 4P	830	3000 K	80	2000 lm
15709500	CorePro LED PLL EM/Mains 16.5W 840 4P	840	4000 K	80	2100 lm
82839700	CorePro LED PLL HF 24W 830 4P 2G11	830	3000 K	83	3200 lm
82841000	CorePro LED PLL HF 24W 840 4P 2G11	840	4000 K	83	3400 lm
15711800	CorePro LED PLL Mains 24W 830 4P	830	3000 K	80	3200 lm
15713200	CorePro LED PLL Mains 24W 840 4P	840	4000 K	80	3400 lm
48676800	CorePro LED PLL HF 8W 830 4P 2G11	830	3000 K	80	960 lm

Order Code	Full Product Name	Kód barvy	Index		
			Náhradní teplota chromatičnosti (jmen.)	barevného podání (jmen.)	Světelný tok (jmen.)
48678200	CorePro LED PLL HF 8W 840 4P 2G11	840	4000 K	80	1000 lm
15699900	CorePro LED PLL EM/Mains 8W 830 4P	830	3000 K	80	960 lm
15701900	CorePro LED PLL EM/Mains 8W 840 4P	840	4000 K	80	1000 lm
48680500	CorePro LED PLL HF 12W 830 4P 2G11	830	3000 K	80	1440 lm
48682900	CorePro LED PLL HF 12W 840 4P 2G11	840	4000 K	80	1500 lm
15703300	CorePro LED PLL EM/Mains 12W 830 4P	830	3000 K	80	1440 lm
15705700	CorePro LED PLL EM/Mains 12W 840 4P	840	4000 K	80	1500 lm

## Mechanical and housing

Order Code	Full Product Name	Úprava žárovky
73966200	CorePro LED PLL HF 16.5W 830 4P 2G11	-
73974700	CorePro LED PLL HF 16.5W 840 4P 2G11	-
15707100	CorePro LED PLL EM/Mains 16.5W 830 4P	Mléčná
15709500	CorePro LED PLL EM/Mains 16.5W 840 4P	Mléčná
82839700	CorePro LED PLL HF 24W 830 4P 2G11	-
82841000	CorePro LED PLL HF 24W 840 4P 2G11	-
15711800	CorePro LED PLL Mains 24W 830 4P	Mléčná
15713200	CorePro LED PLL Mains 24W 840 4P	Mléčná

Order Code	Full Product Name	Úprava žárovky
48676800	CorePro LED PLL HF 8W 830 4P 2G11	Mléčná
48678200	CorePro LED PLL HF 8W 840 4P 2G11	Mléčná
15699900	CorePro LED PLL EM/Mains 8W 830 4P	Mléčná
15701900	CorePro LED PLL EM/Mains 8W 840 4P	Mléčná
48680500	CorePro LED PLL HF 12W 830 4P 2G11	Mléčná
48682900	CorePro LED PLL HF 12W 840 4P 2G11	Mléčná
15703300	CorePro LED PLL EM/Mains 12W 830 4P	Mléčná
15705700	CorePro LED PLL EM/Mains 12W 840 4P	Mléčná

## Temperature

Order Code	Full Product Name	Maximální teplota (jmen.)	Teplota skladování (max.)
73966200	CorePro LED PLL HF 16.5W 830 4P 2G11	70 °C	60 °C
73974700	CorePro LED PLL HF 16.5W 840 4P 2G11	70 °C	60 °C
15707100	CorePro LED PLL EM/Mains 16.5W 830 4P	70 °C	65 °C
15709500	CorePro LED PLL EM/Mains 16.5W 840 4P	70 °C	65 °C
82839700	CorePro LED PLL HF 24W 830 4P 2G11	70 °C	65 °C
82841000	CorePro LED PLL HF 24W 840 4P 2G11	70 °C	65 °C
15711800	CorePro LED PLL Mains 24W 830 4P	75 °C	65 °C
15713200	CorePro LED PLL Mains 24W 840 4P	75 °C	65 °C
48676800	CorePro LED PLL HF 8W 830 4P 2G11	70 °C	65 °C
48678200	CorePro LED PLL HF 8W 840 4P 2G11	70 °C	65 °C
15699900	CorePro LED PLL EM/Mains 8W 830 4P	70 °C	65 °C
15701900	CorePro LED PLL EM/Mains 8W 840 4P	70 °C	65 °C
48680500	CorePro LED PLL HF 12W 830 4P 2G11	70 °C	65 °C
48682900	CorePro LED PLL HF 12W 840 4P 2G11	70 °C	65 °C
15703300	CorePro LED PLL EM/Mains 12W 830 4P	70 °C	65 °C
15705700	CorePro LED PLL EM/Mains 12W 840 4P	70 °C	65 °C

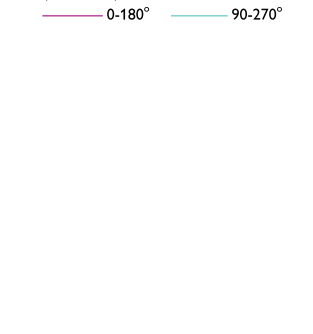
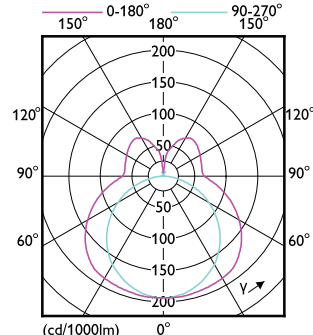
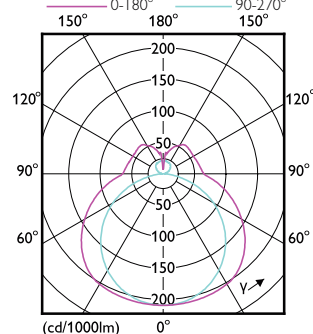
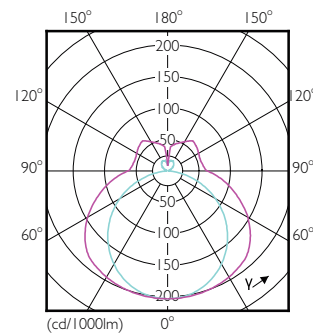

# CorePro LED PLL

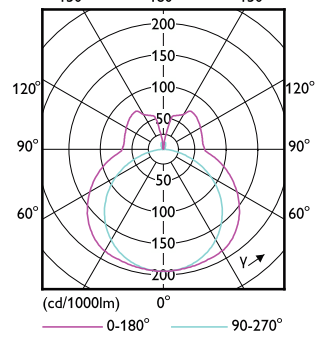
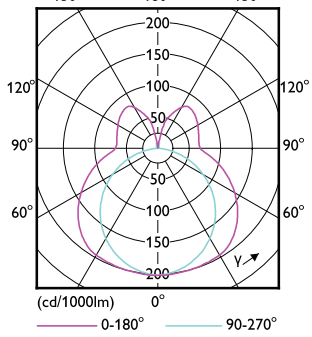
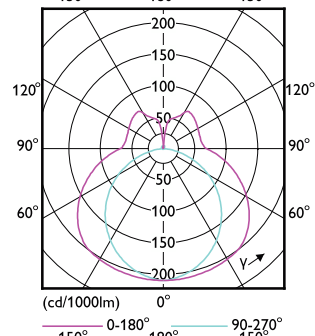
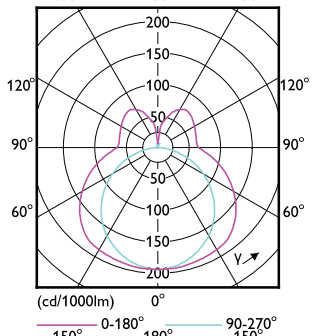
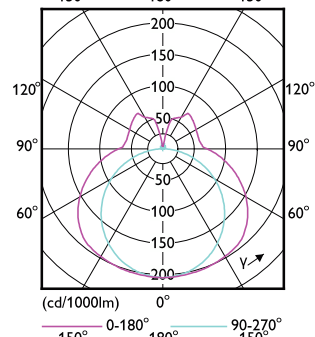
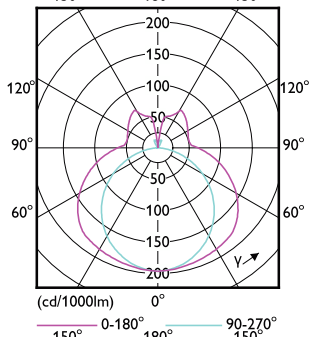
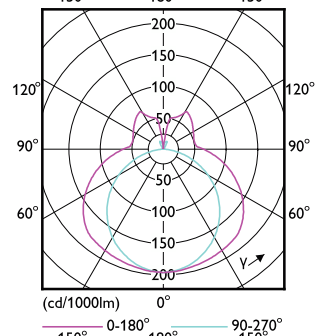
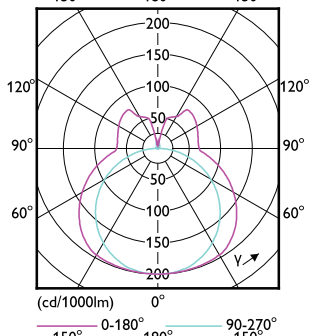
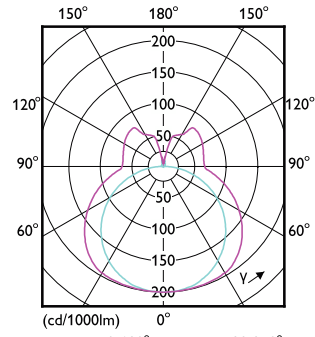
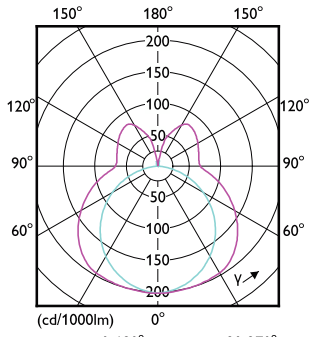

## CorePro LED PLL

